



**TECHNICAL
DATA SHEETS
AND DRAWINGS**

 **moval**
s y s t e m s



COMING SOON

- MANUAL
- EXCHANGEABLE GLASS
- SOUND INSULATION FROM 44DB
- EXTRANARROW ALUMINUM FRAME
- 88MM TOP/BOTTOM
- 38MM LEFT/RIGHT

Diamensi

Thickness in mm	115	
Width in mm	840 - 1300	
Height in mm (máx.)	3000	3500
Construction		
Glazing	Tempered Glass / Laminated Glass	
Extras	Electrically controlled blinds, Magic Glass, Frosted Glass	
Element connections	Complementary geometry aluminium profiles (Positive - Negative)	



TECHNICAL DATA SHEETS AND DRAWINGS INDEX

STANDARD PANEL	4
FIXED TELESCOPIC JAMB	6
TELESCOPIC	8
SINGLE INSET PASSDOOR	10
DOUBLE INSET PASSDOOR	12
FULL-HEIGHT PASSDOOR	14
AQUA PANELS	
GLAZED PANEL	16
TELESCOPIC	18
MULTI	20
SINGLE INSET PASSDOOR	22
DOUBLE INSET PASSDOOR	24
FULL-HEIGHT PASSDOOR	26
AND STACKING SYSTEMS	
	28
FINISHES	
	29
PORTFOLIO	
	32

ALMA PANELS
STANDARD PANEL



ALMA PANELS
STANDARD PANEL

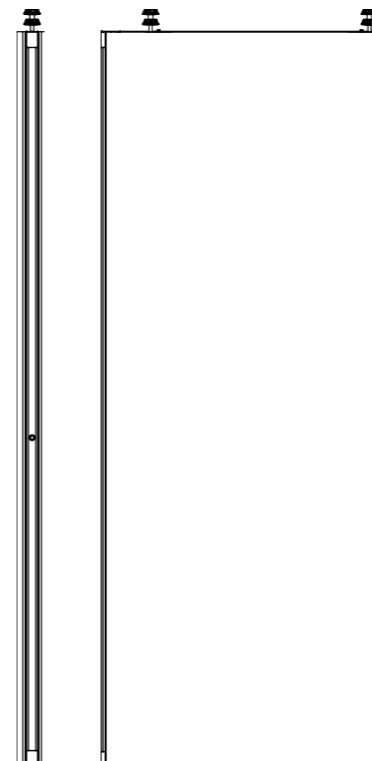

Technical data

Dimensions

Thickness in mm	116	122	134
Width in mm	840 - 1300		
Height in mm (max.)	11000		

Construction

Finishes	MFC/MDF/HPL
Element connections	Complementary geometry aluminium profiles (Positive - Negative)

Operation

Manual	●
Semi-automatic	○
Full automatic	○

Suspension

	Monodirectional / Multidirectional	
--	------------------------------------	--

Technical features	Rw (dB)	Density (kg/m ²)
	Soundproofing to ISO 10140-2:2010*	42
44		40
47		45
50		50
54		55
57	58	

* Laboratory rate.
In the Fully Automatic System, there is a need to have a segmented panel with a minimum height of 460mm.

● Standard equipment
○ Option

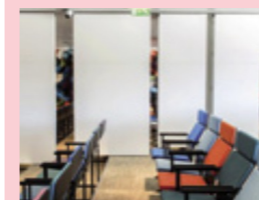

FULL AUTOMATIC

Our fully automatic i-Core system allows the user to position the wall automatically then lock and seal the panels quickly and safely by way of an electronic key-switch. Each panel is driven electrically along the track and contains a wireless two-way control unit which the master control is able to identify & communicate with. This allows the user to program such things as speed of closure and configuration as well as protecting the system in the event of power interruption. Battery back-up is supplied as standard.



SEMI-AUTOMATIC

Our semi-automatic E-Lock system allows the user to fully lock the panels quickly and safely after positioning by way of an electronic key-switch. This allows the wall to automatically seal at the top and bottom to lock it from movement and to insulate it acoustically. The system runs by way of a quick-action worm screw driven by a 24v actuator powered by a protected power supply (certified fully for safety) battery back-up can be supplied for use in case of a cut in mains electricity.

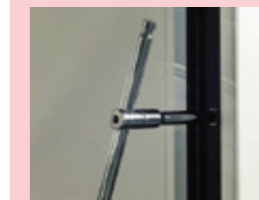

MANUAL

Our Quick-Lock system allows the user to lock the panels quickly and safely after positioning. A simple half-turn of the handle seals the wall at the top and bottom to lock it from movement and to insulate it acoustically.

ALMA PANELS
FIXED TELESCOPIC JAMB



ALMA PANELS
FIXED TELESCOPIC JAMB

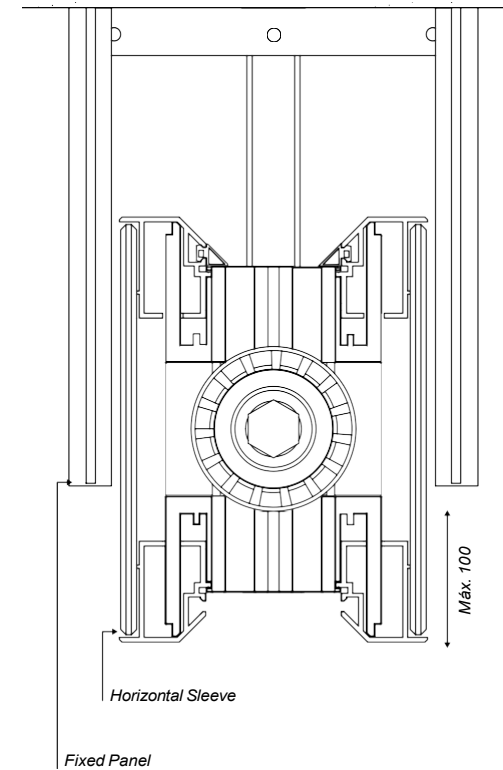

Technical data

Dimensions

Thickness in mm	116	122	134
Width in mm	840 - 1300		
Height in mm (max.)	11000		

Construction

Finishes	MFC/MDF/HPL, Metal finishing, Plasterboard
Element connections	Complementary geometry aluminium profiles (Positive - Negative)

Operation

Manual	●
Semi-automatic	○
Full automatic	○

Suspension

	Monodirectional / Multidirectional	
--	------------------------------------	--

Technical features

	Rw (dB)	Density (kg/m ²)
Soundproofing to ISO 10140-2:2010*	42	39
	44	40
	47	45
	50	50
	54	55
	57	58

* Laboratory rate.
In the Fully Automatic System, there is a need to have a segmented panel with a minimum height of 460mm.

● Standard equipment
○ Option



FULL AUTOMATIC

Our fully automatic i-Core system allows the user to position the wall automatically then lock and seal the panels quickly and safely by way of an electronic key-switch. Each panel is driven electrically along the track and contains a wireless two-way control unit which the master control is able to identify & communicate with. This allows the user to program such things as speed of closure and configuration as well as protecting the system in the event of power interruption. Battery back-up is supplied as standard.



SEMI-AUTOMATIC

Our semi-automatic E-Lock system allows the user to fully lock the panels quickly and safely after positioning by way of an electronic key-switch. This allows the wall to automatically seal at the top and bottom to lock it from movement and to insulate it acoustically. The system runs by way of a quick-action worm screw driven by a 24v actuator powered by a protected power supply (certified fully for safety) battery back-up can be supplied for use in case of a cut in mains electricity.

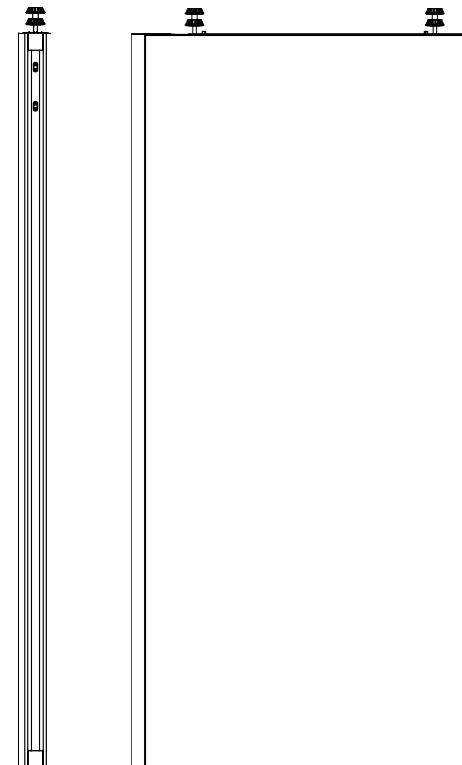

Technical data

Dimensions

Thickness in mm	116	122	134
Width in mm	840 - 1300		
Height in mm (max.)	11000		

Construction

Finishes	MFC/MDF/HPL
Element connections	Complementary geometry aluminium profiles (Positive - Negative)

Operation

Manual	●
Semi-automatic	○
Full automatic	○

Suspension

	Monodirectional / Multidirectional	
--	------------------------------------	--

Technical features

	Rw (dB)	Density (kg/m ²)
Soundproofing to ISO 10140-2:2010*	42	39
	44	40
	47	45
	50	50
	54	55
	57	58

* Laboratory rate.
In the Fully Automatic System, there is a need to have a segmented panel with a minimum height of 460mm.

● Standard equipment
○ Option

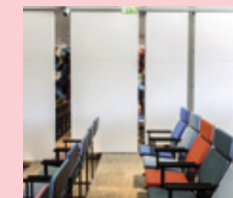

FULL AUTOMATIC

Our fully automatic i-Core system allows the user to position the wall automatically then lock and seal the panels quickly and safely by way of an electronic key-switch. Each panel is driven electrically along the track and contains a wireless two-way control unit which the master control is able to identify & communicate with. This allows the user to program such things as speed of closure and configuration as well as protecting the system in the event of power interruption. Battery back-up is supplied as standard.



SEMI-AUTOMATIC

Our semi-automatic E-Lock system allows the user to fully lock the panels quickly and safely after positioning by way of an electronic key-switch. This allows the wall to automatically seal at the top and bottom to lock it from movement and to insulate it acoustically. The system runs by way of a quick-action worm screw driven by a 24v actuator powered by a protected power supply (certified fully for safety) battery back-up can be supplied for use in case of a cut in mains electricity.

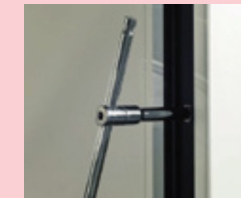

MANUAL

Our Quick-Lock system allows the user to lock the panels quickly and safely after positioning. A simple half-turn of the handle seals the wall at the top and bottom to lock it from movement and to insulate it acoustically.

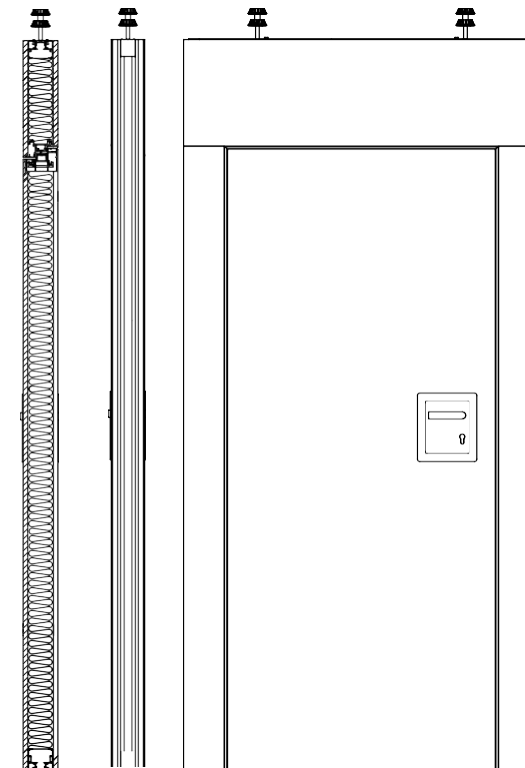
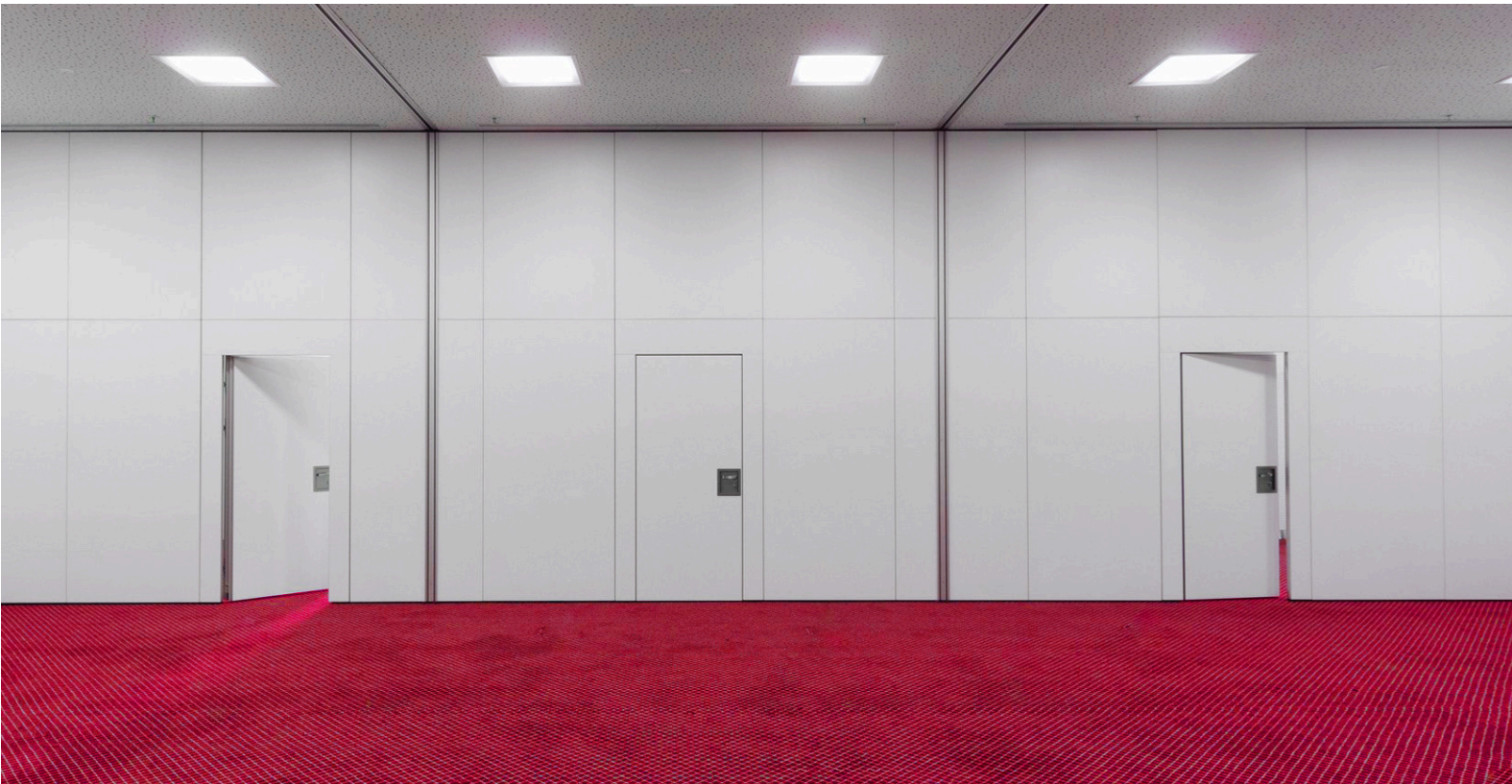

Technical data

Dimensions

Thickness in mm	116	122	134
Width in mm	850 / 900		
Height in mm (max.)	11000		
Width door panel in mm	1200 / 1250		

Construction

Finishes	MFC/MDF/HPL
Element connections	Complementary geometry aluminium profiles (Positive - Negative)

Operation

Manual	●
Semi-automatic	○
Full automatic	○

Suspension

	Monodirectional / Multidirectional
--	------------------------------------

Technical features

	Rw (dB)	Density (kg/m ²)
	42	39
Soundproofing to ISO 10140-2:2010*	44	40
	46	45

* Laboratory rate.
In the Fully Automatic System, there is a need to have a segmented panel with a minimum height of 460mm.

● Standard equipment
○ Option



FRAME & HANDLES

Our inset pass doors are recognized as the most advanced design in the market. All our handles are manufactured in Germany from high-grade stainless steel to exacting standards. Choose a flush handle for solid doors required in areas allowing no protrusion or a pull handle for glazed doors and solid doors in less demanding environments.



HINGE SYSTEM

Our innovative concealed hinge allows full adjustment of the door in three dimensions. The Simonswerk hinge system offers superior engineering and quality with clean aesthetics unmatched by any other manufacturer.



CONTROL DETAILS

Low voltage electrical contacts are housed in our proprietary concave/convex aluminum profiles that guarantee ease of operation and an uninterrupted and safe electrical flow between the panels. The door is equipped with a pressure seal at the bottom, which extends automatically during the closing action of the door.



FULL AUTOMATIC

Our fully automatic i-Core system allows the user to position the wall automatically then lock and seal the panels quickly and safely by way of an electronic key-switch. Each panel is driven electrically along the track and contains a wireless two-way control unit which the master control is able to identify & communicate with. This allows the user to program such things as speed of closure and configuration as well as protecting the system in the event of power interruption. Battery back-up is supplied as standard.



SEMI-AUTOMATIC

Our semi-automatic E-Lock system allows the user to fully lock the panels quickly and safely after positioning by way of an electronic key-switch. This allows the wall to automatically seal at the top and bottom to lock it from movement and to insulate it acoustically. The system runs by way of a quick-action worm screw driven by a 24v actuator powered by a protected power supply (certified fully for safety) battery back-up can be supplied for use in case of a cut in mains electricity.



MANUAL

Our Quick-Lock system allows the user to lock the panels quickly and safely after positioning. A simple half-turn of the handle seals the wall at the top and bottom to lock it from movement and to insulate it acoustically.

ALMA PANELS
DOUBLE INSET PASSDOOR

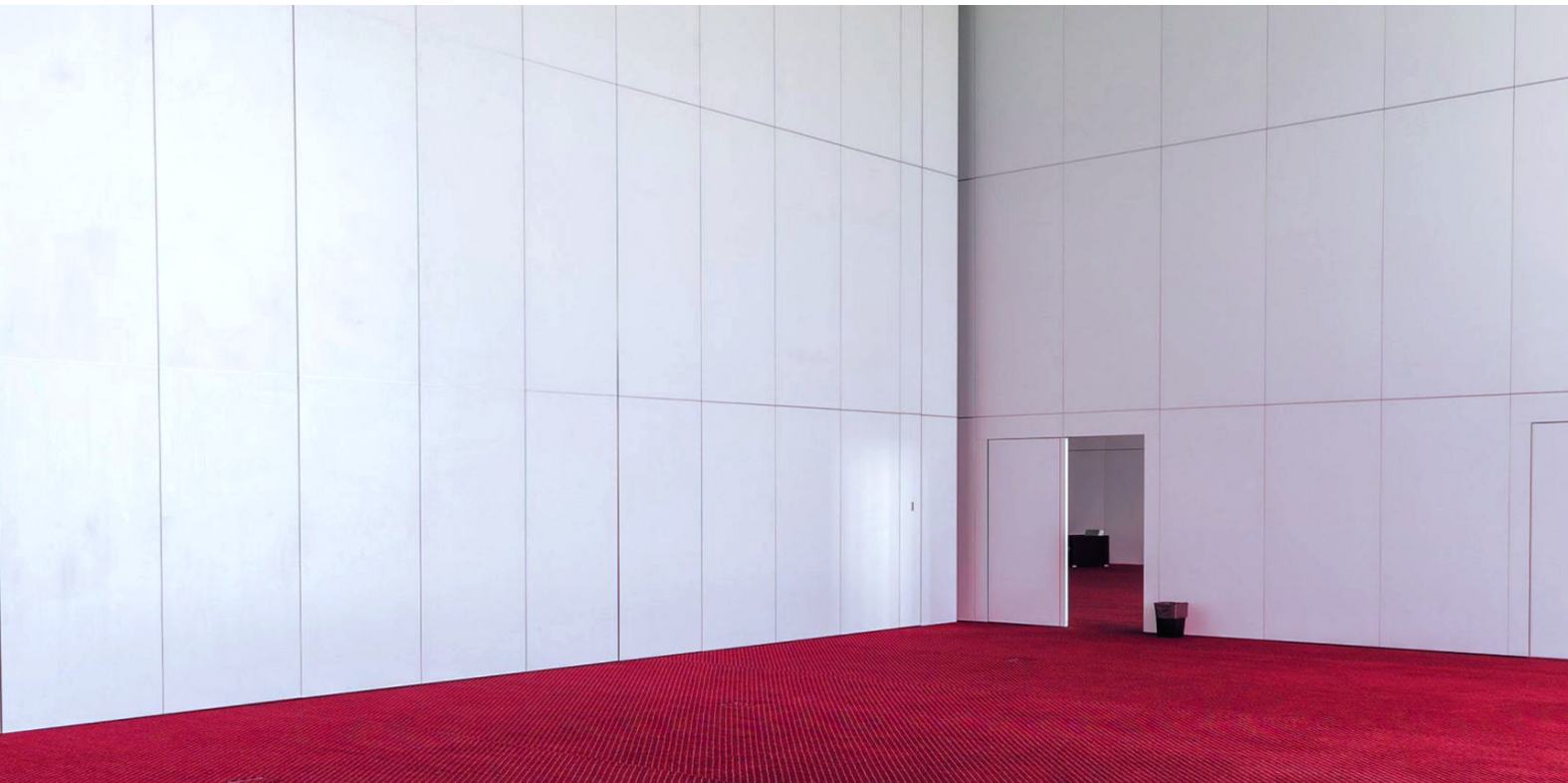

ALMA PANELS
DOUBLE INSET PASSDOOR

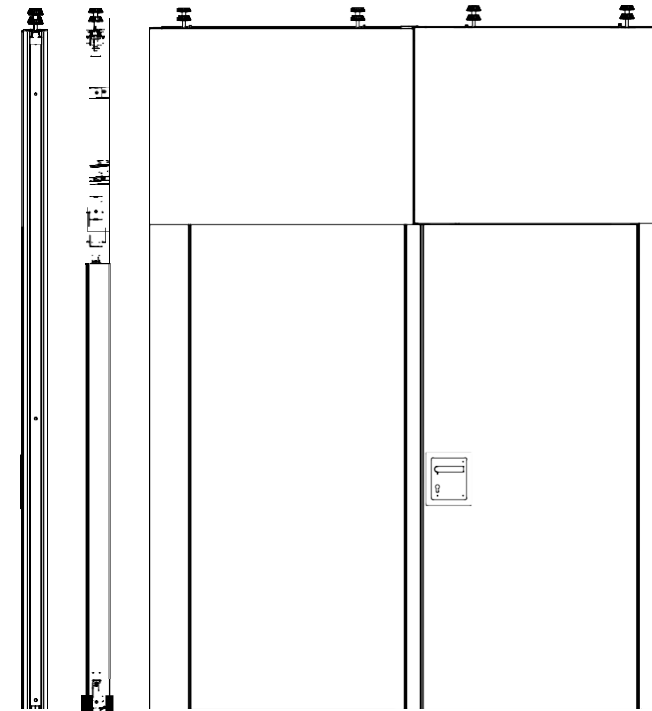

Technical data

Dimensions

Thickness in mm	116	122	134
Width in mm	850 / 900		
Height in mm (max.)	11000		
Width door panel in mm	1200 / 1250		

Construction

Finishes	MFC/MDF/HPL
Element connections	Complementary geometry aluminium profiles (Positive - Negative)

Operation

Manual	●
Semi-automatic	○
Full automatic	○

Suspension

	Monodirectional / Multidirectional	
--	------------------------------------	--

Technical features	Rw (dB)	Density (kg/m ²)
	42	39
Soundproofing to ISO 10140-2:2010*	44	40
	47	45
	50	50
	54	55
	57	58

* Laboratory rate.

In the Fully Automatic System, there is a need to have a segmented panel with a minimum height of 460mm.

● Standard equipment

○ Option



FRAME & HANDLES

Our inset pass doors are recognized as the most advanced design in the market. All our handles are manufactured in Germany from high-grade stainless steel to exacting standards. Choose a flush handle for solid doors required in areas allowing no protrusion or a pull handle for glazed doors and solid doors in less demanding environments.



HINGE SYSTEM

Our innovative concealed hinge allows full adjustment of the door in three dimensions. The Simonswerk hinge system offers superior engineering and quality with clean aesthetics unmatched by any other manufacturer.



CONTROL DETAILS

Low voltage electrical contacts are housed in our proprietary concave/convex aluminum profiles that guarantee ease of operation and an uninterrupted and safe electrical flow between the panels. The door is equipped with a pressure seal at the bottom, which extends automatically during the closing action of the door.

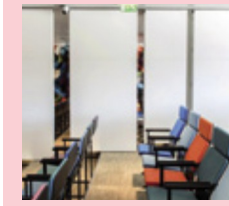

FULL AUTOMATIC

Our fully automatic i-Core system allows the user to position the wall automatically then lock and seal the panels quickly and safely by way of an electronic key-switch. Each panel is driven electrically along the track and contains a wireless two-way control unit which the master control is able to identify & communicate with. This allows the user to program such things as speed of closure and configuration as well as protecting the system in the event of power interruption. Battery back-up is supplied as standard.



SEMI-AUTOMATIC

Our semi-automatic E-Lock system allows the user to fully lock the panels quickly and safely after positioning by way of an electronic key-switch. This allows the wall to automatically seal at the top and bottom to lock it from movement and to insulate it acoustically. The system runs by way of a quick-action worm screw driven by a 24v actuator powered by a protected power supply (certified fully for safety) battery back-up can be supplied for use in case of a cut in mains electricity.



MANUAL

Our Quick-Lock system allows the user to lock the panels quickly and safely after positioning. A simple half-turn of the handle seals the wall at the top and bottom to lock it from movement and to insulate it acoustically.

ALMA PANELS
FULL - HEIGHT PASSDOOR

ALMA PANELS
FULL - HEIGHT PASSDOOR

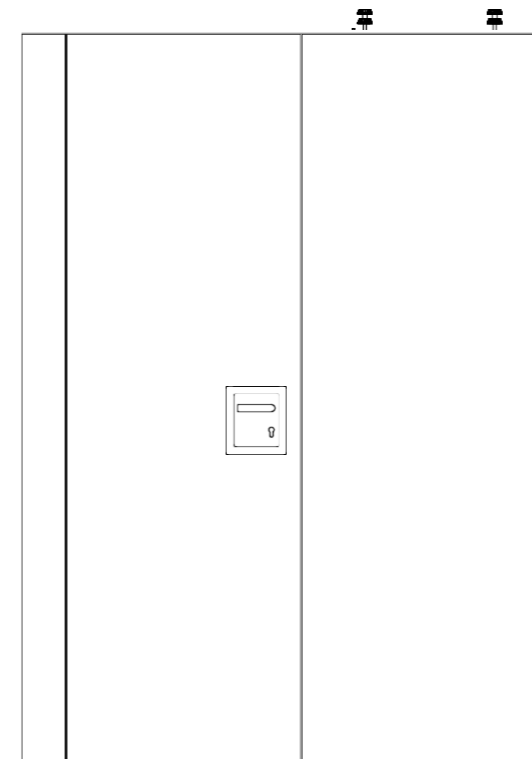

Technical data

Dimensions

Thickness in mm	116	122	134
Width in mm	1050		
Height in mm (max.)	4000		

Construction

Finishes	MFC/MDF/HPL
Element connections	Complementary geometry aluminium profiles (Positive - Negative)

Operation

Manual	●
Semi-automatic	○
Full automatic	○

Suspension

	Monodirectional / Multidirectional	
--	------------------------------------	--

Technical features

	Rw (dB)	Density (kg/m ²)
Soundproofing to ISO 10140-2:2010*	42	39
	44	40
	47	45
	50	50
	54	55
	57	58

* Laboratory rate.
In the Fully Automatic System, there is a need to have a segmented panel with a minimum height of 460mm.

● Standard equipment
○ Option



FRAME & HANDLES

Our inset pass doors are recognized as the most advanced design in the market. All our handles are manufactured in Germany from high-grade stainless steel to exacting standards. Choose a flush handle for solid doors required in areas allowing no protrusion or a pull handle for glazed doors and solid doors in less demanding environments.



HINGE SYSTEM

Our innovative concealed hinge allows full adjustment of the door in three dimensions. The Simonswerk hinge system offers superior engineering and quality with clean aesthetics unmatched by any other manufacturer.



CONTROL DETAILS

Low voltage electrical contacts are housed in our proprietary concave/convex aluminum profiles that guarantee ease of operation and an uninterrupted and safe electrical flow between the panels. The door is equipped with a pressure seal at the bottom, which extends automatically during the closing action of the door.



SEMI-AUTOMATIC

Our semi-automatic E-Lock system allows the user to fully lock the panels quickly and safely after positioning by way of an electronic key-switch. This allows the wall to automatically seal at the top and bottom to lock it from movement and to insulate it acoustically. The system runs by way of a quick-action worm screw driven by a 24v actuator powered by a protected power supply (certified fully for safety) battery back-up can be supplied for use in case of a cut in mains electricity.

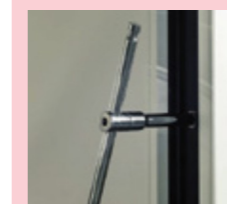

MANUAL

Our Quick-Lock system allows the user to lock the panels quickly and safely after positioning. A simple half-turn of the handle seals the wall at the top and bottom to lock it from movement and to insulate it acoustically.

AQUAPANELS
GLAZED PANEL



AQUAPANELS
GLAZED PANEL

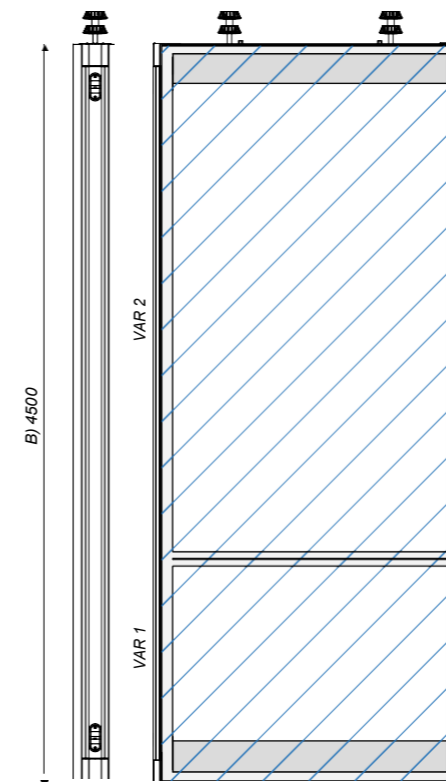
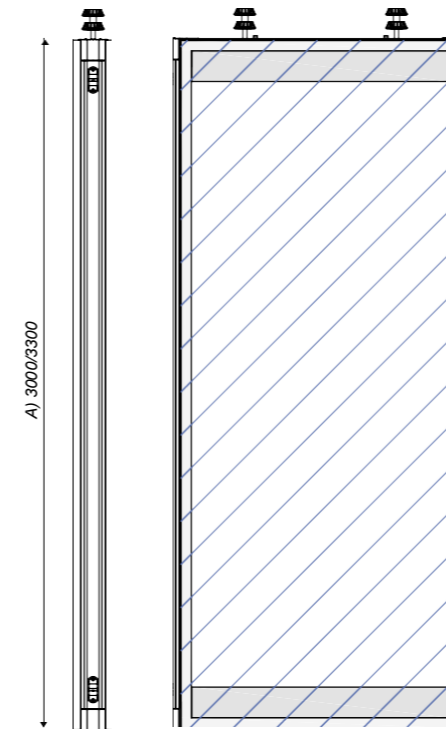

Technical data

Dimensions

Thickness in mm	115	119
Width in mm	840 - 1300	
Height in mm (máx.)	A) 3000 / 3300	B) 4500

Construction

Glazing	Tempered Glass / Laminated Glass
Extras	Electrically controlled blinds, Magic Glass, Frosted Glass
Element connections	Complementary geometry aluminium profiles (Positive - Negative)

Frame profile

Black/White	<input checked="" type="radio"/>
Others	<input type="radio"/>

Equipment details

Semi-automatic	<input checked="" type="radio"/>
Full automatic	<input type="radio"/>

Suspension

Monodirectional / Multidirectional

Technical specifications

	Rw (dB)	Density (kg/m ²)
Sound insulation according to ISO 10140-2:2010 standard*	44	39
	49	48

* Laboratory rate.
In the Fully Automatic System, there is a need to have a segmented panel with a minimum height of 460mm.

Standard equipment
 Option

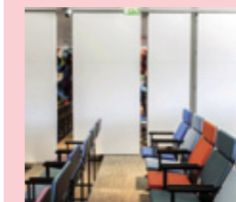

FULL AUTOMATIC

Our fully automatic i-Core system allows the user to position the wall automatically then lock and seal the panels quickly and safely by way of an electronic key-switch. Each panel is driven electrically along the track and contains a wireless two-way control unit which the master control is able to identify & communicate with. This allows the user to program such things as speed of closure and configuration as well as protecting the system in the event of power interruption. Battery back-up is supplied as standard.



SEMI-AUTOMATIC

Our semi-automatic E-Lock system allows the user to fully lock the panels quickly and safely after positioning by way of an electronic key-switch. This allows the wall to automatically seal at the top and bottom to lock it from movement and to insulate it acoustically. The system runs by way of a quick-action worm screw driven by a 24v actuator powered by a protected power supply (certified fully for safety) battery back-up can be supplied for use in case of a cut in mains electricity.

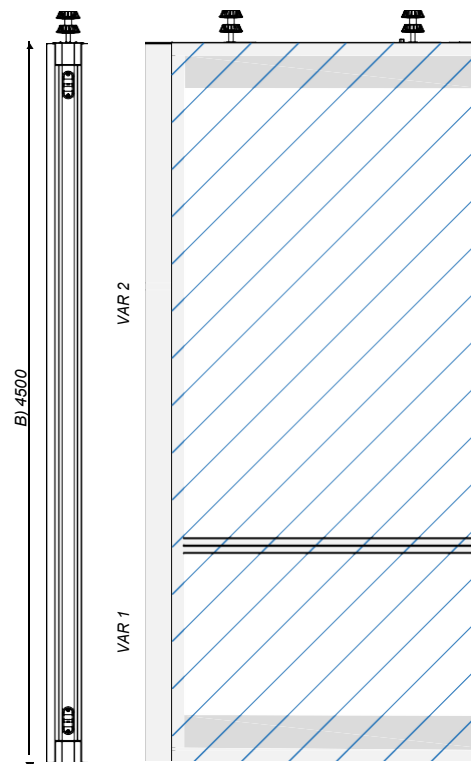
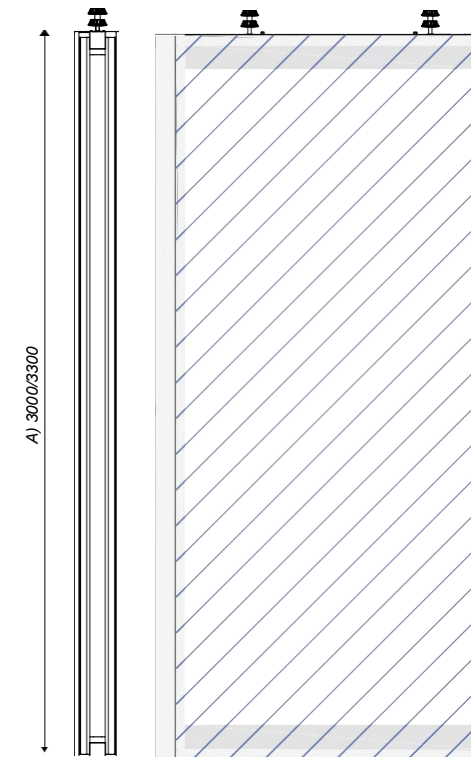

Technical data

Dimensions

Thickness in mm	115	119
Width in mm	840 - 1300	
Height in mm (máx.)	A) 3000 / 3300	B) 4500

Construction

Glazing	Tempered Glass / Laminated Glass
Extras	Electrically controlled blinds, Magic Glass, Frosted Glass
Element connections	Complementary geometry aluminium profiles (Positive - Negative)

Frame profile

Black/White	●
Others	○

Equipment details

Semi-automatic	●
Full automatic	○

Suspension

	Monodirectional / Multidirectional
--	------------------------------------

Technical specifications

	Rw (dB)	Density (kg/m ²)
Sound insulation according to ISO 10140-2:2010 standard*	44	39
	49	48

* Laboratory rate.

In the Fully Automatic System, there is a need to have a segmented panel with a minimum height of 460mm.

● Standard equipment

○ Option

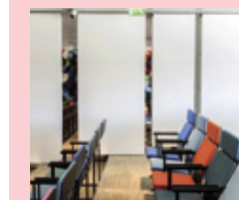

FULL AUTOMATIC

Our fully automatic i-Core system allows the user to position the wall automatically then lock and seal the panels quickly and safely by way of an electronic key-switch. Each panel is driven electrically along the track and contains a wireless two-way control unit which the master control is able to identify & communicate with. This allows the user to program such things as speed of closure and configuration as well as protecting the system in the event of power interruption. Battery back-up is supplied as standard.



SEMI-AUTOMATIC

Our semi-automatic E-Lock system allows the user to fully lock the panels quickly and safely after positioning by way of an electronic key-switch. This allows the wall to automatically seal at the top and bottom to lock it from movement and to insulate it acoustically. The system runs by way of a quick-action worm screw driven by a 24v actuator powered by a protected power supply (certified fully for safety) battery back-up can be supplied for use in case of a cut in mains electricity.

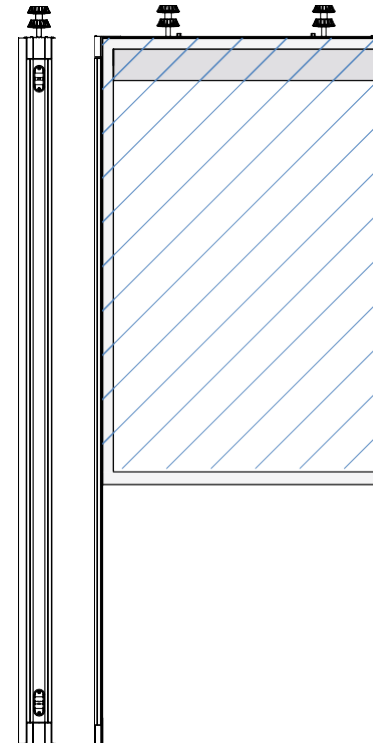

Technical data

Dimensions

Thickness in mm	115	119
Width in mm	840 - 1300	
Height in mm (máx.)	3000	3500

Construction

Possibility to alternate solid and glass coverings

Glazing	Tempered Glass / Laminated Glass
Extras	Electrically controlled blinds, Magic Glass, Frosted Glass
Element connections	Complementary geometry aluminium profiles (Positive - Negative)

Aluminum paint

Anodized	<input checked="" type="radio"/>
Black / White / Others	<input type="radio"/>

Frame profile

Black/White	<input checked="" type="radio"/>
Others	<input type="radio"/>

Equipment details

Semi-automatic	<input checked="" type="radio"/>
Full automatic	<input type="radio"/>

Suspension

Monodirectional / Multidirectional

Technical specifications

	Rw (dB)	Density (kg/m ²)
Sound insulation according to ISO 10140-2:2010 standard*	44	39
	49	48

* Laboratory rate.
In the Fully Automatic System, there is a need to have a segmented panel with a minimum height of 460mm.

● Standard equipment
○ Option

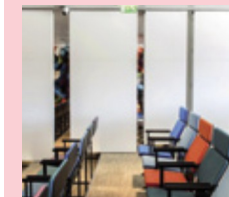

FULL AUTOMATIC

Our fully automatic i-Core system allows the user to position the wall automatically then lock and seal the panels quickly and safely by way of an electronic key-switch. Each panel is driven electrically along the track and contains a wireless two-way control unit which the master control is able to identify & communicate with. This allows the user to program such things as speed of closure and configuration as well as protecting the system in the event of power interruption. Battery back-up is supplied as standard.



SEMI-AUTOMATIC

Our semi-automatic E-Lock system allows the user to fully lock the panels quickly and safely after positioning by way of an electronic key-switch. This allows the wall to automatically seal at the top and bottom to lock it from movement and to insulate it acoustically. The system runs by way of a quick-action worm screw driven by a 24v actuator powered by a protected power supply (certified fully for safety) battery back-up can be supplied for use in case of a cut in mains electricity.

NOTE

This template can be used in the following options:

- . Telescopic
- . Full-height pass door
- . Single inset pass door

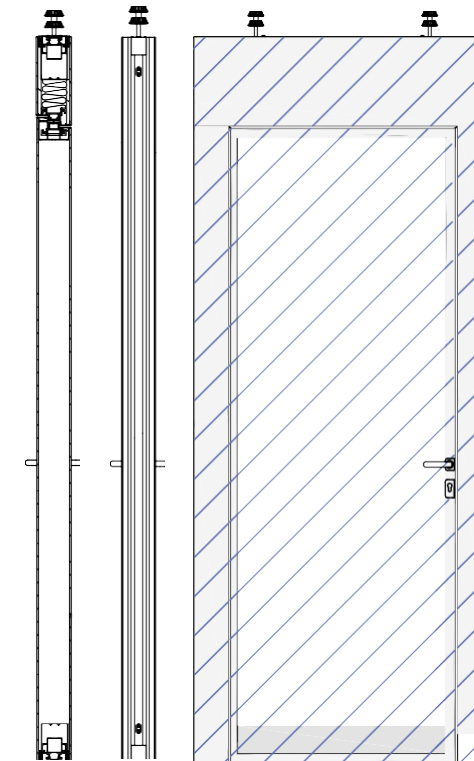

Technical data

Dimensions

Thickness in mm	115	119
Width in mm	850 / 900	
Height in mm (máx.)	3000 / 4500	
Width door panel in mm	1200 / 1250	

Construction

Glazing	Tempered Glass / Laminated Glass
Extras	Electrically controlled blinds, Magic Glass, Frosted Glass
Element connections	Complementary geometry aluminium profiles (Positive - Negative)

Frame profile

Black/White	●
Others	○

Equipment details

Semi-automatic	●
Full automatic	○

Suspension

	Monodirectional / Multidirectional	
--	------------------------------------	--

Technical specifications

Sound insulation according to ISO 10140-2:2010 standard*	Rw (dB)	Density (kg/m ²)
	44	39
	49	48

* Laboratory rate.
In the Fully Automatic System, there is a need to have a segmented panel with a minimum height of 460mm.

● Standard equipment
○ Option



FRAME & HANDLES

Our inset pass doors are recognized as the most advanced design in the market. All our handles are manufactured in Germany from high-grade stainless steel to exacting standards. Choose a flush handle for solid doors required in areas allowing no protrusion or a pull handle for glazed doors and solid doors in less demanding environments.



HINGE SYSTEM

Our innovative concealed hinge allows full adjustment of the door in three dimensions. The Simonswerk hinge system offers superior engineering and quality with clean aesthetics unmatched by any other manufacturer.



CONTROL DETAILS

Low voltage electrical contacts are housed in our proprietary concave/convex aluminum profiles that guarantee ease of operation and an uninterrupted and safe electrical flow between the panels. The door is equipped with a pressure seal at the bottom, which extends automatically during the closing action of the door.

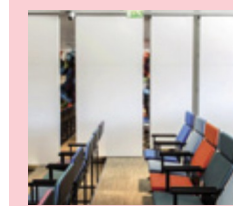
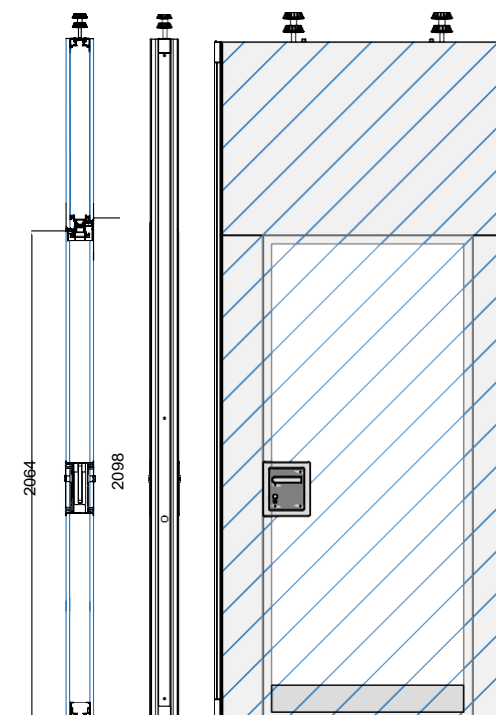

FULL AUTOMATIC

Our fully automatic i-Core system allows the user to position the wall automatically then lock and seal the panels quickly and safely by way of an electronic key-switch. Each panel is driven electrically along the track and contains a wireless two-way control unit which the master control is able to identify & communicate with. This allows the user to program such things as speed of closure and configuration as well as protecting the system in the event of power interruption. Battery back-up is supplied as standard.



SEMI-AUTOMATIC

Our semi-automatic E-Lock system allows the user to fully lock the panels quickly and safely after positioning by way of an electronic key-switch. This allows the wall to automatically seal at the top and bottom to lock it from movement and to insulate it acoustically. The system runs by way of a quick-action worm screw driven by a 24v actuator powered by a protected power supply (certified fully for safety) battery back-up can be supplied for use in case of a cut in mains electricity.

AQUAPANELS
DOUBLE INSET PASSDOOR

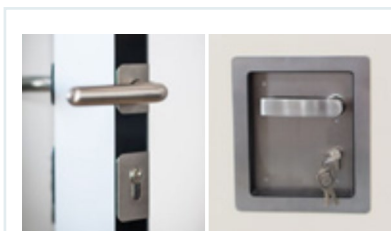

FRAME & HANDLES

Our inset pass doors are recognized as the most advanced design in the market. All our handles are manufactured in Germany from high-grade stainless steel to exacting standards. Choose a flush handle for solid doors required in areas allowing no protrusion or a pull handle for glazed doors and solid doors in less demanding environments.



HINGE SYSTEM

Our innovative concealed hinge allows full adjustment of the door in three dimensions. The Simonswerk hinge system offers superior engineering and quality with clean aesthetics unmatched by any other manufacturer.



CONTROL DETAILS

Low voltage electrical contacts are housed in our proprietary concave/convex aluminum profiles that guarantee ease of operation and an uninterrupted and safe electrical flow between the panels. The door is equipped with a pressure seal at the bottom, which extends automatically during the closing action of the door.

AQUAPANELS
DOUBLE INSET PASSDOOR

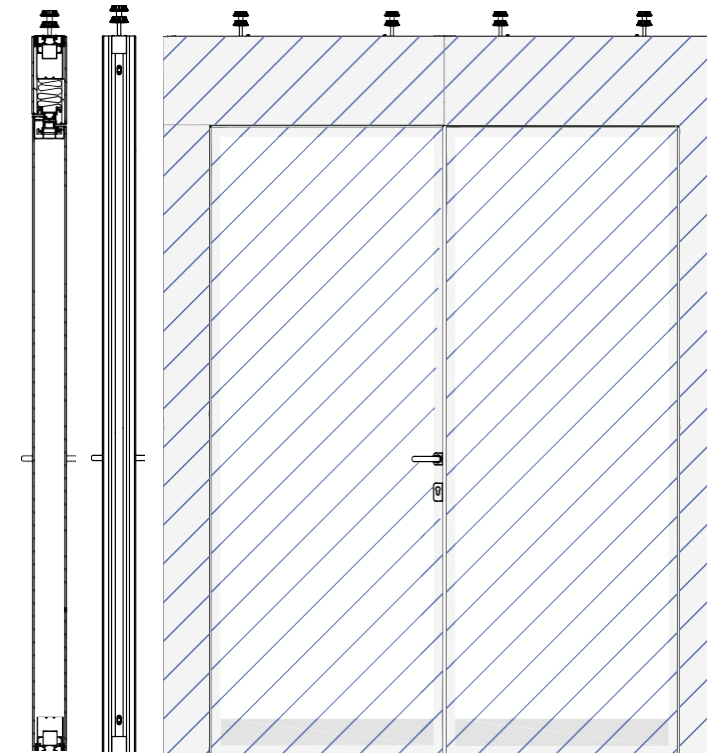

Technical data

Dimensions

Thickness in mm	115	119
Width in mm	840 – 1300	
Height in mm (máx.)	3000 / 4500	
Width door panel in mm	1200/1250	

Construction

Glazing	Tempered Glass / Laminated Glass
Extras	Electrically controlled blinds, Magic Glass, Frosted Glass
Element connections	Complementary geometry aluminium profiles (Positive - Negative)

Frame profile

Black/White	●
Others	○

Equipment details

Semi-automatic	●
Full automatic	○

Suspension

	Monodirectional / Multidirectional	
--	------------------------------------	--

Technical specifications

	Rw (dB)	Density (kg/m ²)
Sound insulation according to ISO 10140-2:2010 standard*	44	39
	49	48

* Laboratory rate. In the Fully Automatic System, there is a need to have a segmented panel with a minimum height of 460mm.

● Standard equipment
○ Option

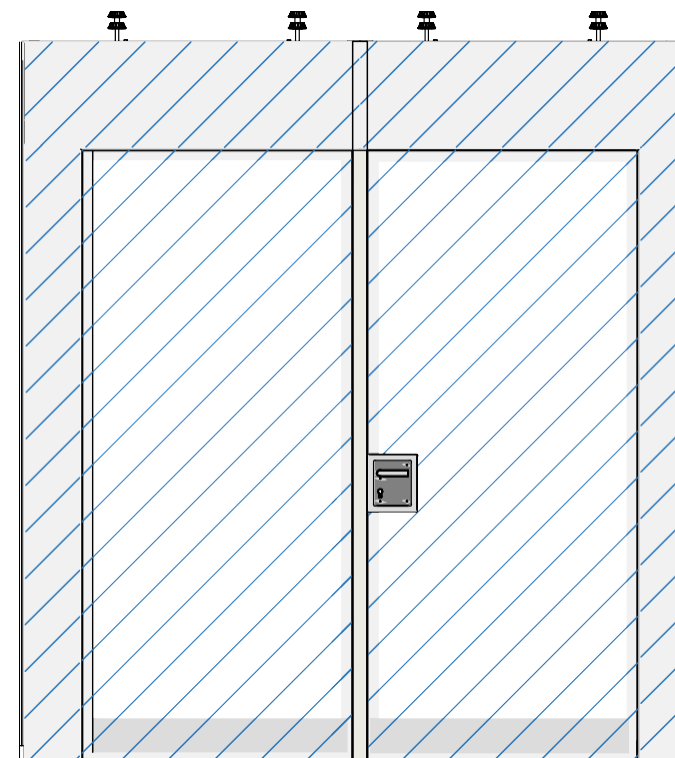

SEMI-AUTOMATIC

Our semi-automatic E-Lock system allows the user to fully lock the panels quickly and safely after positioning by way of an electronic key-switch. This allows the wall to automatically seal at the top and bottom to lock it from movement and to insulate it acoustically. The system runs by way of a quick-action worm screw driven by a 24v actuator powered by a protected power supply (certified fully for safety) battery back-up can be supplied for use in case of a cut in mains electricity.

AQUAPANELS
FULL-HEIGHT PASSDOOR

AQUAPANELS
FULL-HEIGHT PASSDOOR

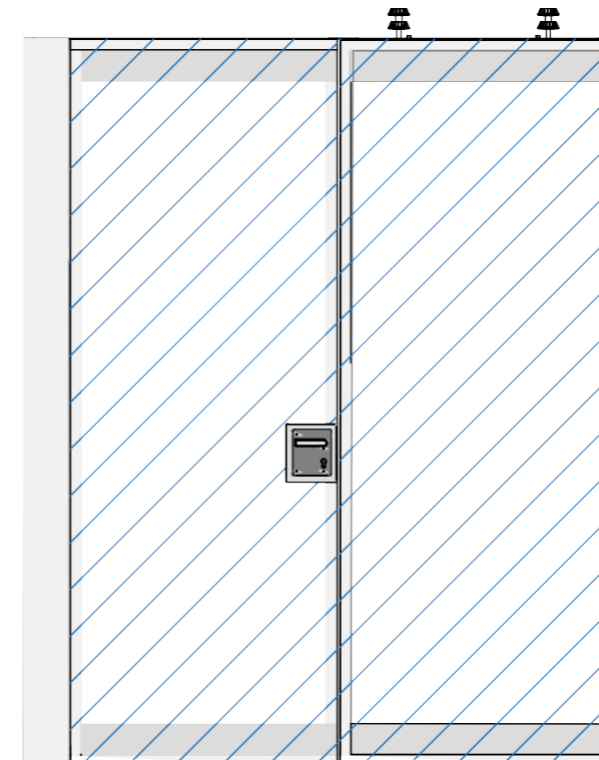
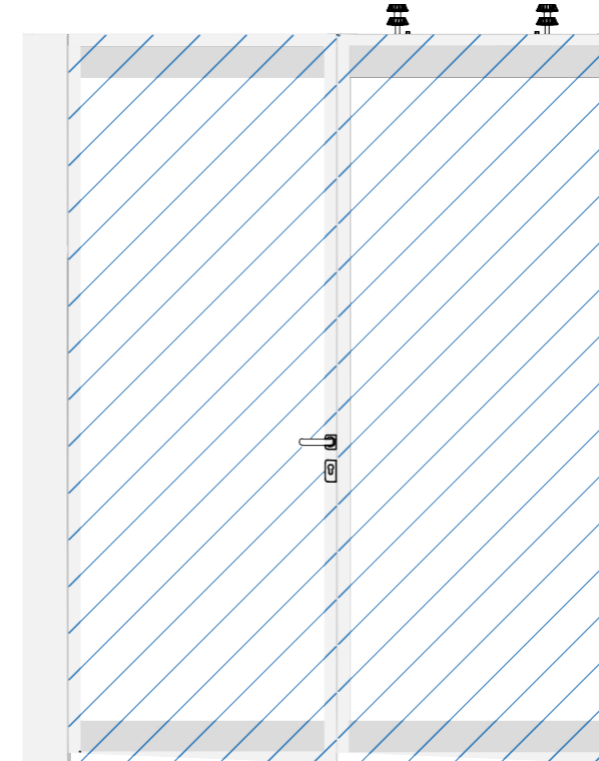
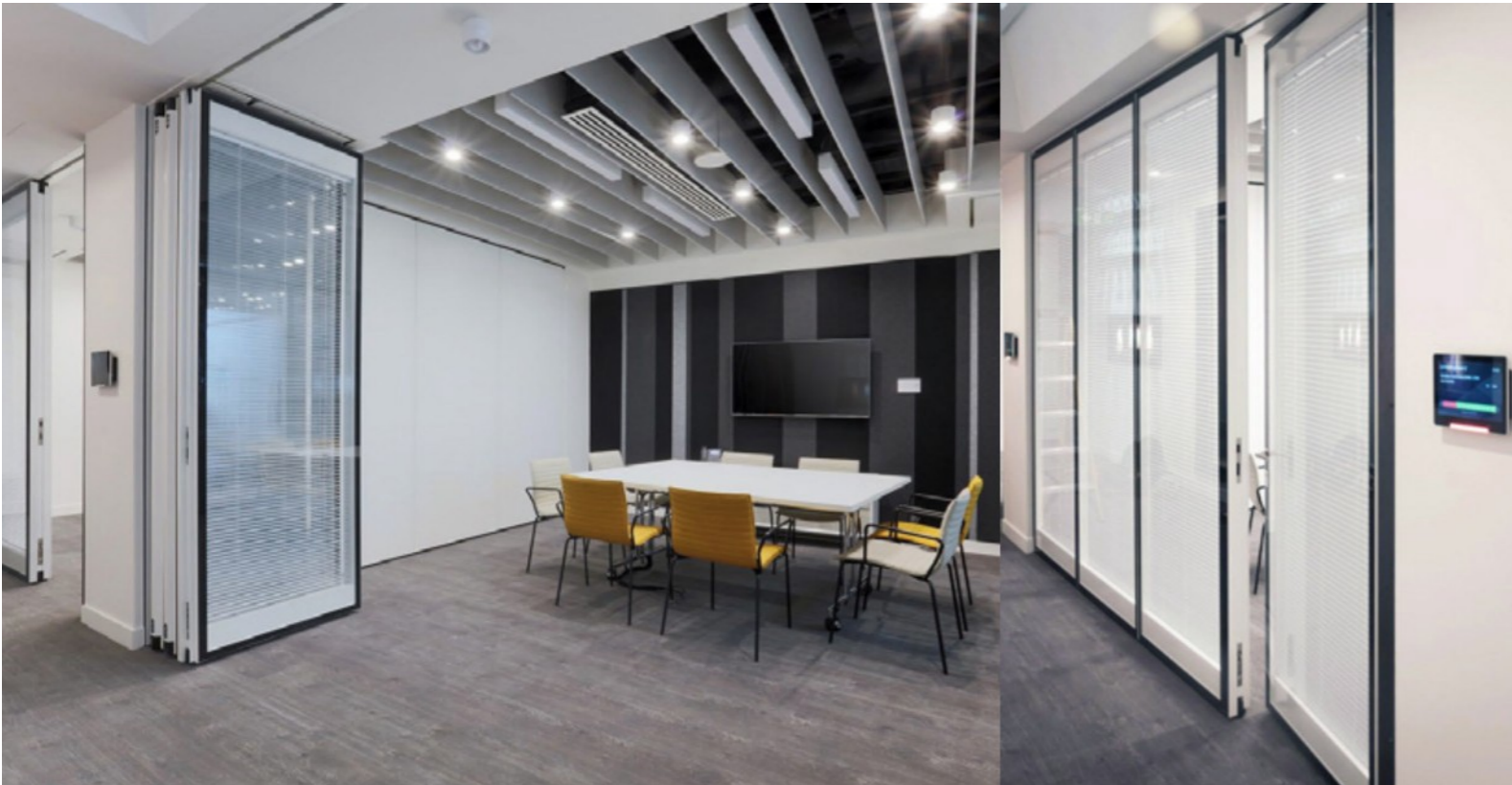

Technical data

Dimensions

Thickness in mm	115	119
Width in mm	1050	
Height in mm (máx.)	3000	

Construction

Glazing	Tempered Glass / Laminated Glass	
Extras	Electrically controlled blinds, Magic Glass, Frosted Glass	

Frame profile

Black/White	<input checked="" type="radio"/>
Others	<input type="radio"/>

Equipment details

Semi-automatic	<input checked="" type="radio"/>
Full automatic	<input type="radio"/>

Suspension

	Fixed	
--	-------	--

Technical specifications

	Rw (dB)	Density (kg/m ²)
Sound insulation according to ISO 10140-2:2010 standard*	44	39
	49	48

* Laboratory rate.
In the Fully Automatic System, there is a need to have a segmented panel with a minimum height of 460mm.

● Standard equipment
○ Option



FRAME & HANDLES

Our inset pass doors are recognized as the most advanced design in the market. All our handles are manufactured in Germany from high-grade stainless steel to exacting standards. Choose a flush handle for solid doors required in areas allowing no protrusion or a pull handle for glazed doors and solid doors in less demanding environments.



HINGE SYSTEM

Our innovative concealed hinge allows full adjustment of the door in three dimensions. The Simonswerk hinge system offers superior engineering and quality with clean aesthetics unmatched by any other manufacturer.



CONTROL DETAILS

Low voltage electrical contacts are housed in our proprietary concave/convex aluminum profiles that guarantee ease of operation and an uninterrupted and safe electrical flow between the panels. The door is equipped with a pressure seal at the bottom, which extends automatically during the closing action of the door.



SEMI-AUTOMATIC

Our semi-automatic E-Lock system allows the user to fully lock the panels quickly and safely after positioning by way of an electronic key-switch. This allows the wall to automatically seal at the top and bottom to lock it from movement and to insulate it acoustically. The system runs by way of a quick-action worm screw driven by a 24v actuator powered by a protected power supply (certified fully for safety) battery back-up can be supplied for use in case of a cut in mains electricity.

CEILING TRACK, SUSPENSION TYPES AND STACKING SYSTEMS

FINISHES
GROUP 1 / 2 / 3

Stacking Systems

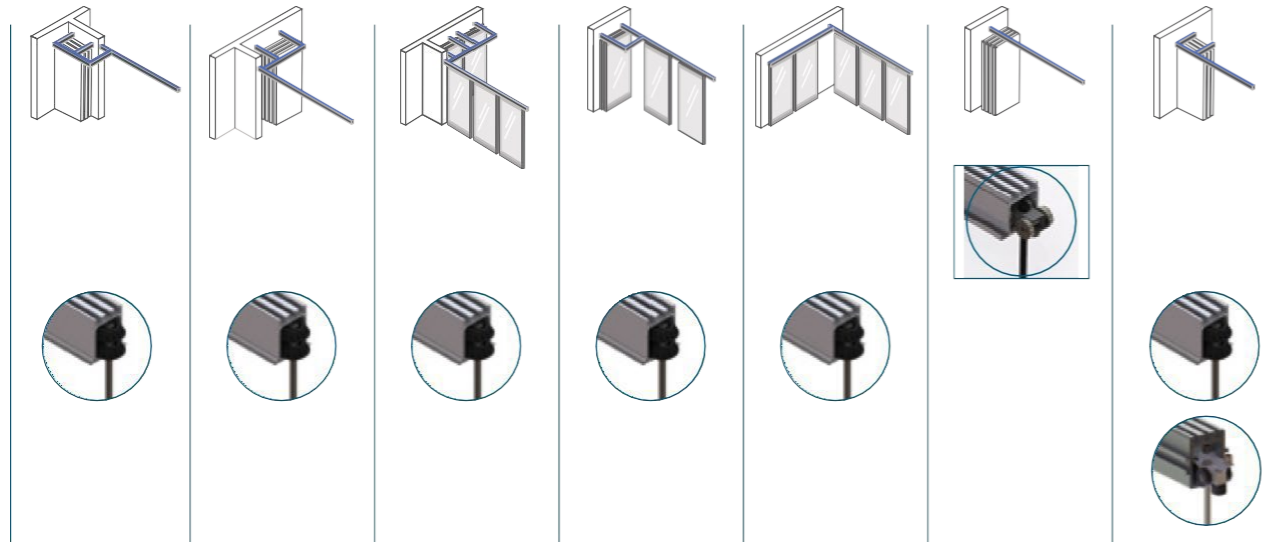

Unicolor



W908 ST2



W980 ST2



U708 ST9

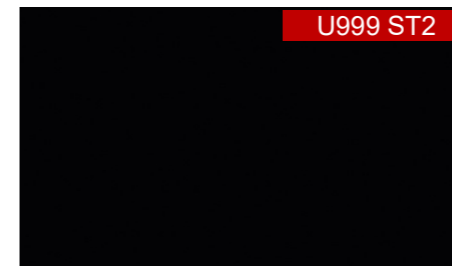

U999 ST2

Ceiling Track



TRACK TYPE UD
Uni-Directional
Aluminum track profiles extruded from architectural grade 6063-T6 alloy. Load bearing capacity: 358Kg per panel.



TRACK TYPE MDS
Standard Multi-Directional
Aluminum track profiles extruded from architectural grade 6063-T6 alloy. Load bearing capacity: 453Kg per panel.



TRACK TYPE MDH
Heavy duty Multi-Directional
Aluminum track profiles extruded from architectural grade 6063-T6 alloy. Load bearing capacity: 850Kg per panel.



SUSPENSION TYPES

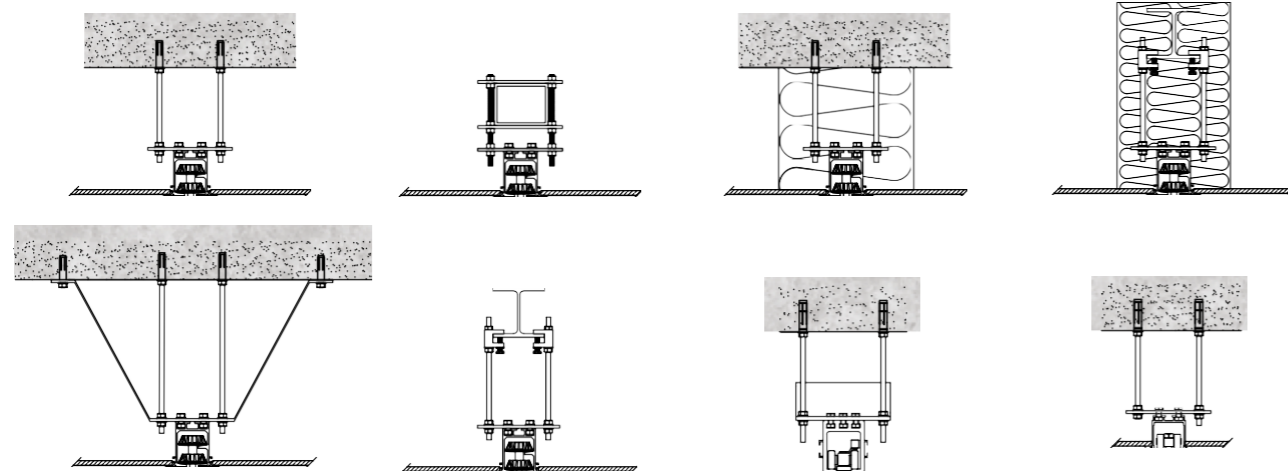

FINISHES
GROUP 4

Unicolor / Wood Imitation

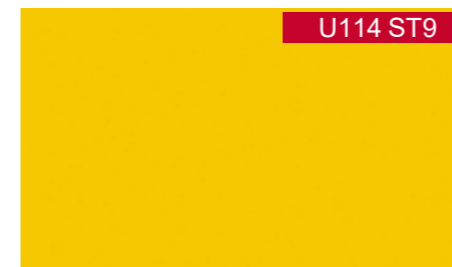

U114 ST9



U156 ST9



U775 ST9



U763 ST9

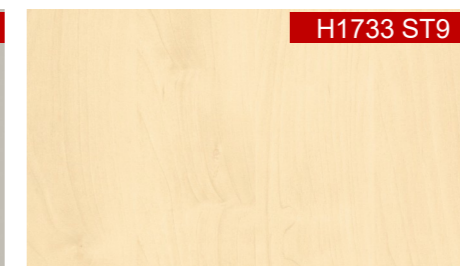

H1733 ST9

FINISHES
GROUP 5/6/7/8

Unicolor / Wood Imitation



FINISHES
GROUP 5/6/7/8

Continuation



Note: Material available for immediate delivery from the supplier.
Stock PCTS White MFC.

PORTFOLIO



SPAIN

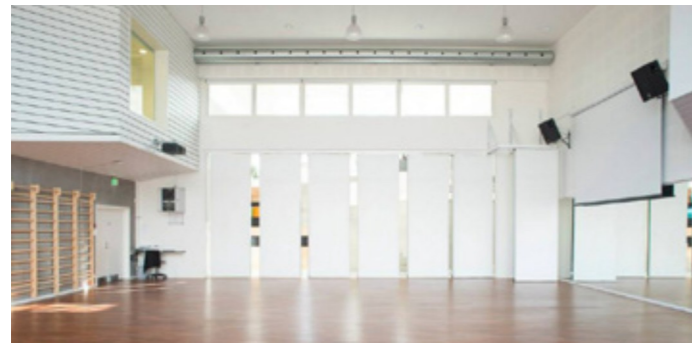

DENMARK

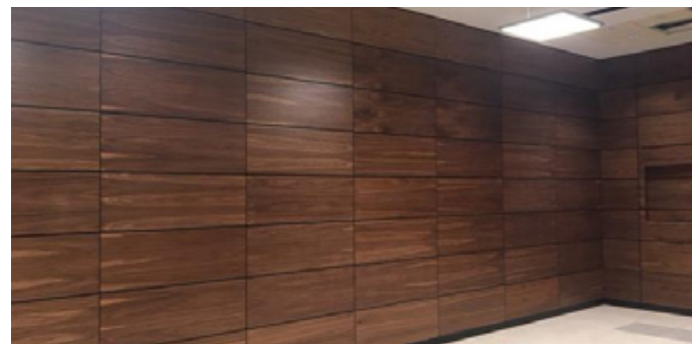

MALTA



LUXEMBOURG



MOROCCO



RUSSIA

PORTFOLIO



FRANCE



UAE (DUBAI)



ENGLAND



BELGIUM



USA



OMAN

PORTFOLIO



SWITZERLAND

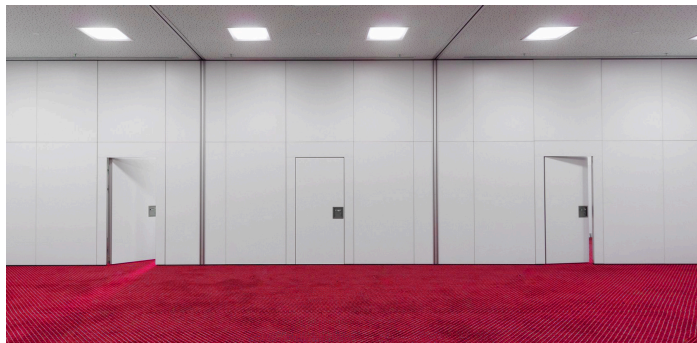

PORTUGAL

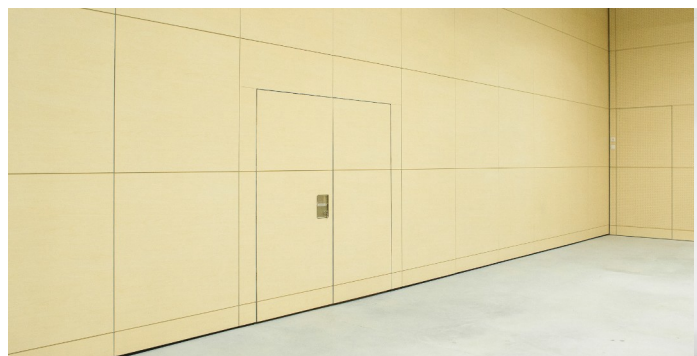

FRANCE



ENGLAND

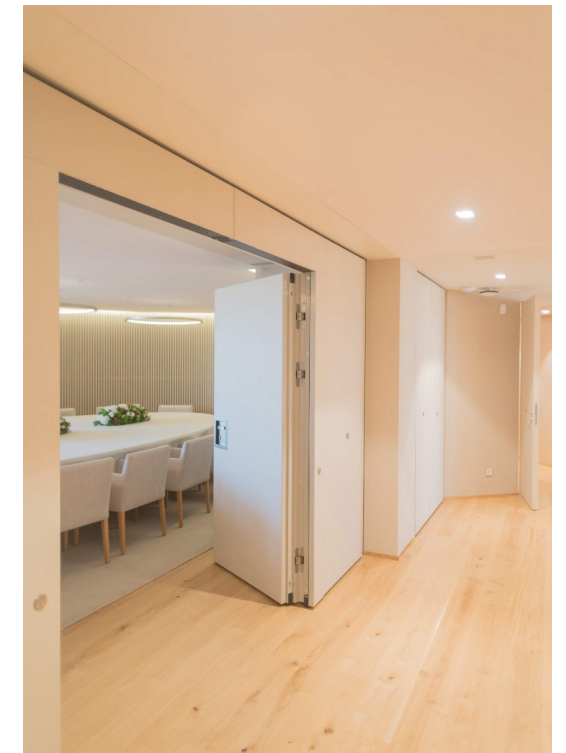

PORTUGAL

PORTFOLIO



PORTUGAL



CANADA

INDIA

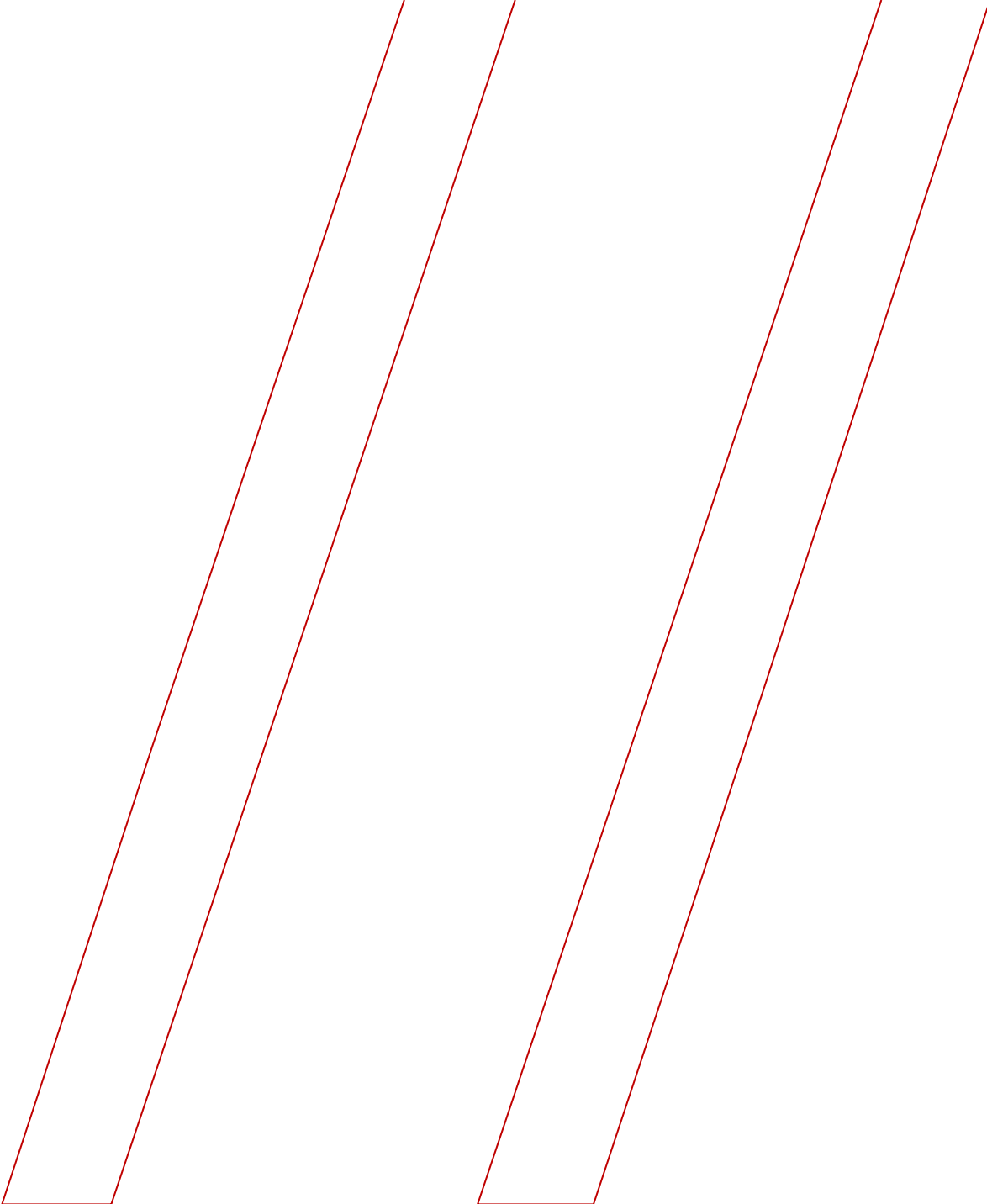

PO Box No: 25422
Global Business Centre 2,
C Ring Road, Doha, Qatar
Mob: +974 3036 1560
Tel: +974 4402 3014
Email: sales@movalsystems.com
www.movalsystems.com